

CoolMOS™ Power Transistor
Features

- Lowest figure of merit $R_{ON} \times Q_g$
- Ultra low gate charge
- Extreme dv/dt rated
- High peak current capability
- Pb-free lead plating; RoHS compliant
- Qualified according to JEDEC⁰ for target applications

CoolMOS CP is designed for:

- Hard and softswitching SMPS topologies
- CCM PFC for Notebook adapter, PDP and LCD TV
- PWM for Notebook adapter, PDP and LCD TV

Product Summary

$V_{DS} @ T_{jmax}$	550	V
$R_{DS(on),max}$	0.299	Ω
$Q_{g,typ}$	23	nC

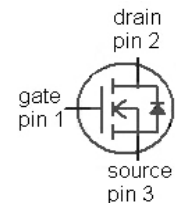
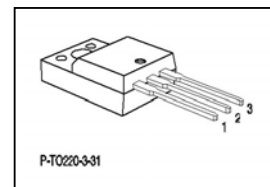
TO220 Full PAK

Type	Package	Marking
IPA50R299CP	PG-TO220FP	5R299CP

Maximum ratings, at $T_j=25\text{ °C}$, unless otherwise specified

Parameter	Symbol	Conditions	Value	Unit
Continuous drain current ¹⁾	I_D	$T_C=25\text{ °C}$	12	A
		$T_C=100\text{ °C}$	8	
Pulsed drain current ²⁾	$I_{D,pulse}$	$T_C=25\text{ °C}$	26	
Avalanche energy, single pulse	E_{AS}	$I_D=4.4\text{ A}, V_{DD}=50\text{ V}$	289	mJ
Avalanche energy, repetitive t_{AR} ^{2),3)}	E_{AR}	$I_D=4.4\text{ A}, V_{DD}=50\text{ V}$	0.44	
Avalanche current, repetitive t_{AR} ^{2),3)}	I_{AR}		4.4	A
MOSFET dv/dt ruggedness	dv/dt	$V_{DS}=0\dots400\text{ V}$	50	V/ns
Gate source voltage	V_{GS}	static	± 20	V
		AC ($f>1\text{ Hz}$)	± 30	
Power dissipation	P_{tot}	$T_C=25\text{ °C}$	104	W
Operating and storage temperature	T_j, T_{stg}		-55 ... 150	$^{\circ}\text{C}$
Mounting torque		M2.5 screws	60	Ncm

Maximum ratings, at $T_j=25\text{ °C}$, unless otherwise specified

Parameter	Symbol	Conditions	Value	Unit
Continuous diode forward current ¹⁾	I_S	$T_C=25\text{ °C}$	6.6	A
Diode pulse current ²⁾	$I_{S,pulse}$		26	
Reverse diode dv/dt ⁴⁾	dv/dt		15	V/ns

Parameter	Symbol	Conditions	Values			Unit
			min.	typ.	max.	

Thermal characteristics

Thermal resistance, junction - case	R_{thJC}		-	-	1.2	K/W
Thermal resistance, junction - ambient	R_{thJA}	leaded	-	-	62	
Soldering temperature, wavesoldering only allowed at leads	T_{sold}	1.6 mm (0.063 in.) from case for 10 s	-	-	260	°C

Electrical characteristics, at $T_j=25\text{ °C}$, unless otherwise specified
Static characteristics

Drain-source breakdown voltage	$V_{(BR)DSS}$	$V_{GS}=0\text{ V}$, $I_D=250\text{ }\mu\text{A}$	500	-	-	V
Gate threshold voltage	$V_{GS(th)}$	$V_{DS}=V_{GS}$, $I_D=0.44\text{ mA}$	2.5	3	3.5	
Zero gate voltage drain current	I_{DSS}	$V_{DS}=500\text{ V}$, $V_{GS}=0\text{ V}$, $T_j=25\text{ °C}$	-	-	1	μA
		$V_{DS}=500\text{ V}$, $V_{GS}=0\text{ V}$, $T_j=150\text{ °C}$	-	10	-	
Gate-source leakage current	I_{GSS}	$V_{GS}=20\text{ V}$, $V_{DS}=0\text{ V}$	-	-	100	nA
Drain-source on-state resistance	$R_{DS(on)}$	$V_{GS}=10\text{ V}$, $I_D=6.6\text{ A}$, $T_j=25\text{ °C}$	-	0.27	0.299	Ω
		$V_{GS}=10\text{ V}$, $I_D=6.6\text{ A}$, $T_j=150\text{ °C}$	-	0.68	-	
Gate resistance	R_G	$f=1\text{ MHz}$, open drain	-	2.2	-	Ω

Parameter	Symbol	Conditions	Values			Unit
			min.	typ.	max.	

Dynamic characteristics

Input capacitance	C_{iss}	$V_{GS}=0\text{ V}, V_{DS}=100\text{ V},$ $f=1\text{ MHz}$	-	1190	-	pF
Output capacitance	C_{oss}		-	53	-	
Effective output capacitance, energy related ⁵⁾	$C_{o(er)}$	$V_{GS}=0\text{ V}, V_{DS}=0\text{ V}$ to 400 V	-	50	-	
Effective output capacitance, time related ⁶⁾	$C_{o(tr)}$		-	110	-	
Turn-on delay time	$t_{d(on)}$	$V_{DD}=400\text{ V},$ $V_{GS}=10\text{ V}, I_D=6.6\text{ A},$ $R_G=27.9\ \Omega$	-	35	-	ns
Rise time	t_r		-	14	-	
Turn-off delay time	$t_{d(off)}$		-	80	-	
Fall time	t_f		-	12	-	

Gate Charge Characteristics

Gate to source charge	Q_{gs}	$V_{DD}=400\text{ V}, I_D=6.6\text{ A},$ $V_{GS}=0\text{ to }10\text{ V}$	-	5	-	nC
Gate to drain charge	Q_{gd}		-	7	-	
Gate charge total	Q_g		-	23	31	
Gate plateau voltage	$V_{plateau}$		-	5.2	-	V

Reverse Diode

Diode forward voltage	V_{SD}	$V_{GS}=0\text{ V}, I_F=6.6\text{ A},$ $T_j=25\text{ }^\circ\text{C}$	-	0.9	1.2	V
Reverse recovery time	t_{rr}	$V_R=400\text{ V}, I_F=I_S,$ $di_F/dt=100\text{ A}/\mu\text{s}$	-	260	-	ns
Reverse recovery charge	Q_{rr}		-	2.6	-	μC
Peak reverse recovery current	I_{rrm}		-	21	-	A

⁰⁾ J-STD20 and JESD22

¹⁾ Limited only by $T_{j,max}$
²⁾ Pulse width t_p limited by $T_{j,max}$
³⁾ Repetitive avalanche causes additional power losses that can be calculated as $P_{AV}=E_{AR} \cdot f$.

⁴⁾ $I_{SD} \leq I_D, di/dt \leq 200\text{ A}/\mu\text{s}, V_{DClink}=400\text{ V}, V_{peak} < V_{(BR)DSS}, T_j < T_{j,max}$, identical low and high side switch

⁵⁾ $C_{o(er)}$ is a fixed capacitance that gives the same stored energy as C_{oss} while V_{DS} is rising from 0 to 80% V_{DSS} .

⁶⁾ $C_{o(tr)}$ is a fixed capacitance that gives the same charging time as C_{oss} while V_{DS} is rising from 0 to 80% V_{DSS} .

1 Power dissipation

$$P_{tot} = f(T_C)$$

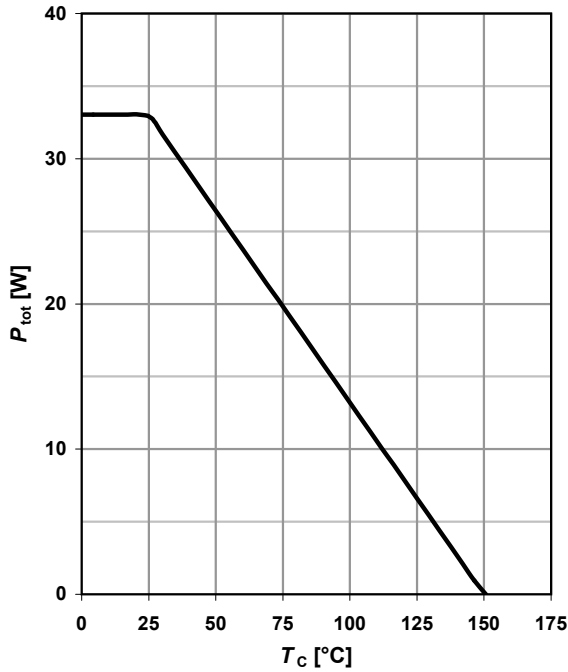

2 Safe operating area

$$I_D = f(V_{DS}); T_C = 25\text{ °C}; D = 0$$

parameter: t_p

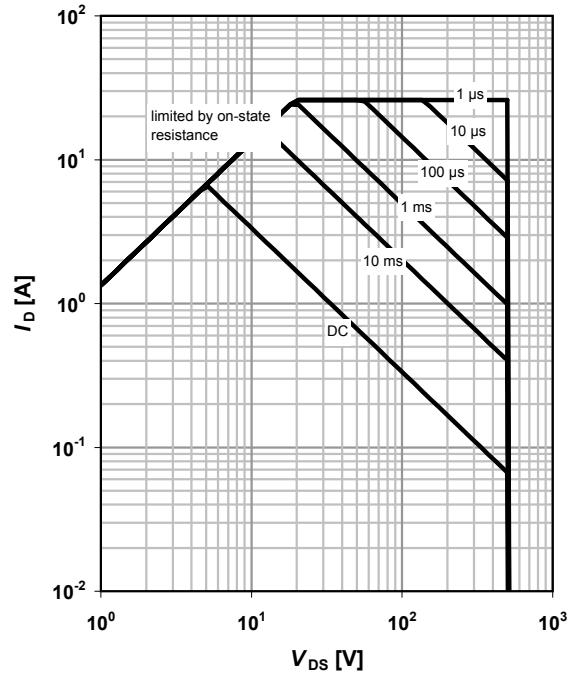

3 Max. transient thermal impedance

$$Z_{th(jc)} = f(t_p)$$

parameter: $D = t_p / T$

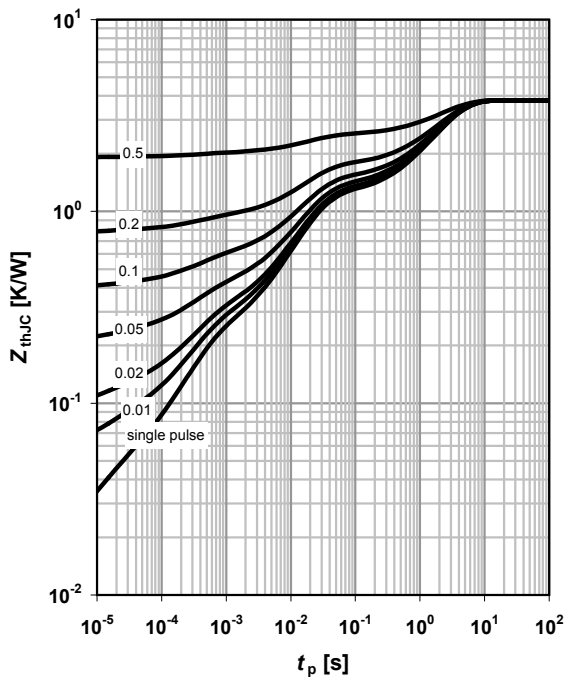

4 Typ. output characteristics

$$I_D = f(V_{DS}); T_j = 25\text{ °C}$$

parameter: V_{GS}

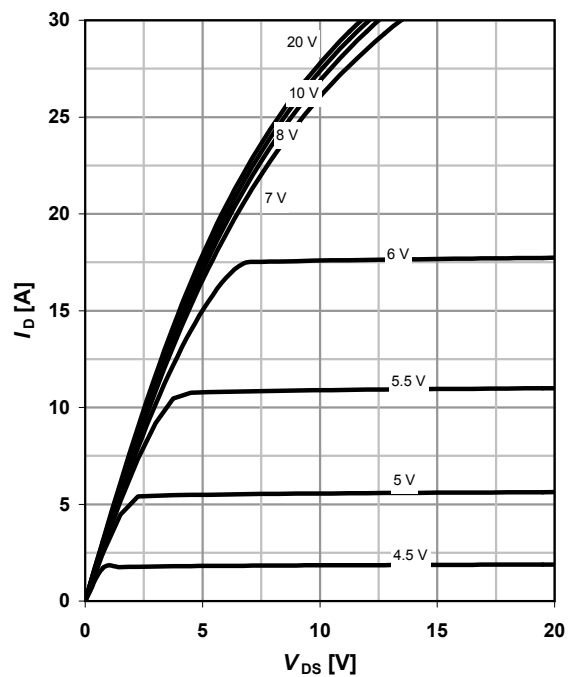

5 Typ. output characteristics

$I_D = f(V_{DS}); T_j = 150\text{ }^\circ\text{C}$

parameter: V_{GS}

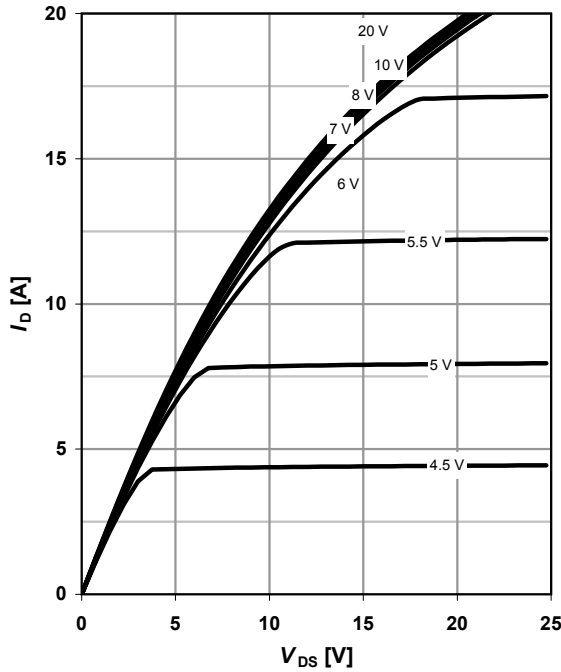

6 Typ. drain-source on-state resistance

$R_{DS(on)} = f(I_D); T_j = 150\text{ }^\circ\text{C}$

parameter: V_{GS}

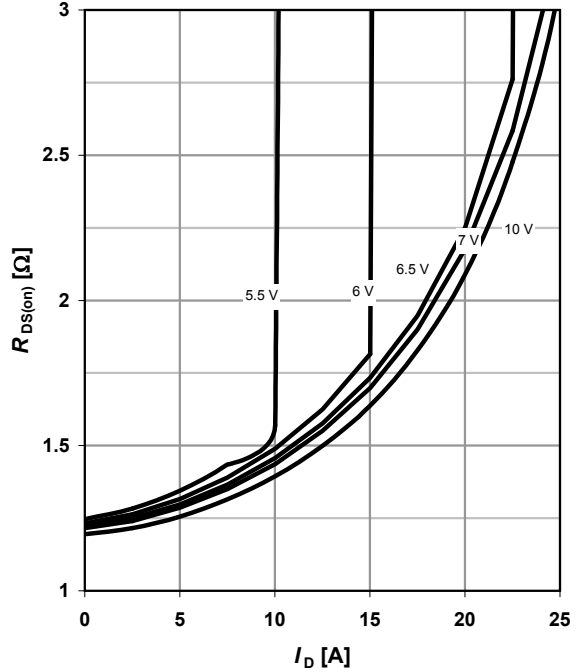

7 Drain-source on-state resistance

$R_{DS(on)} = f(T_j); I_D = 6.6\text{ A}; V_{GS} = 10\text{ V}$

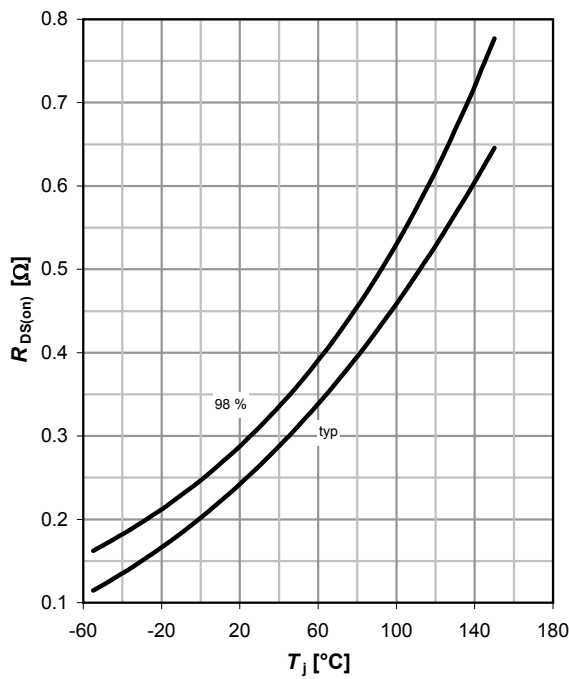

8 Typ. transfer characteristics

$I_D = f(V_{GS}); |V_{DS}| > 2I_D/R_{DS(on)max}$

parameter: T_j

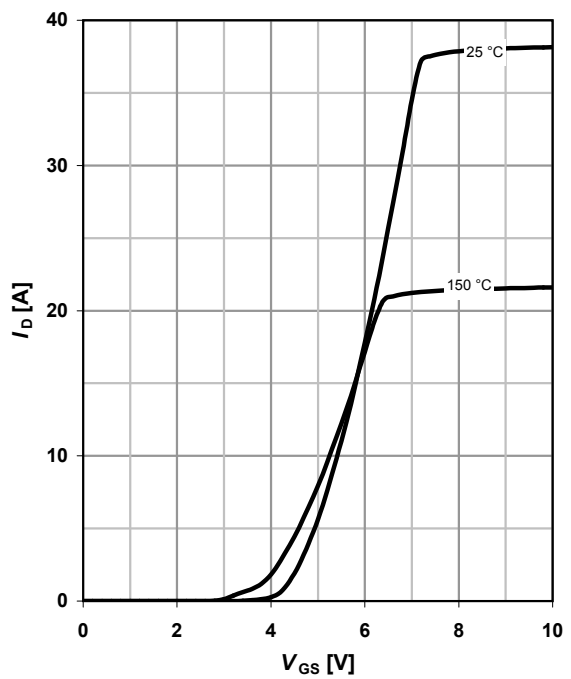

9 Typ. gate charge

$V_{GS}=f(Q_{gate}); I_D=6.6 \text{ A pulsed}$

parameter: V_{DD}

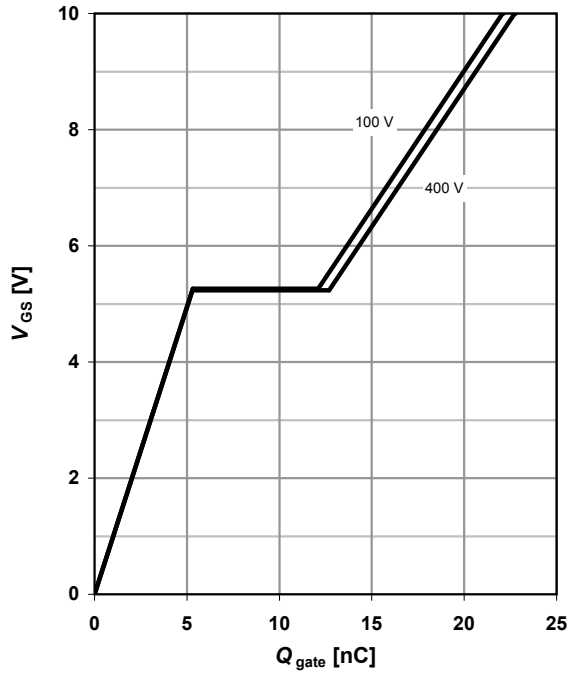

10 Forward characteristics of reverse diode

$I_F=f(V_{SD})$

parameter: T_j

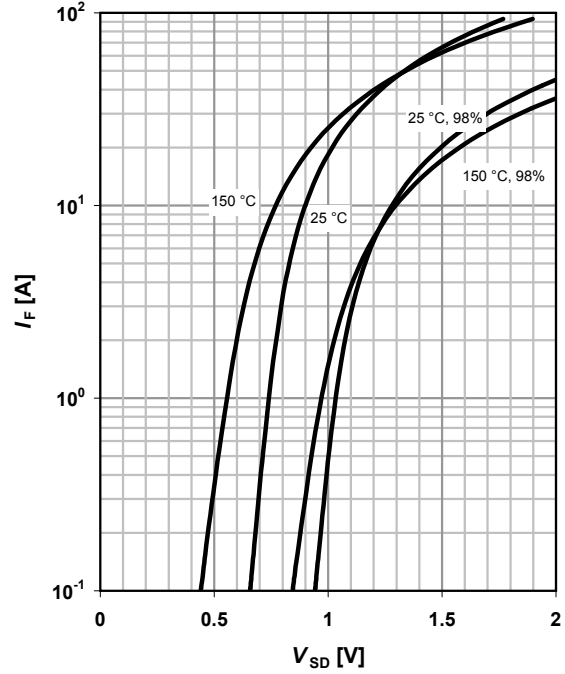

11 Avalanche energy

$E_{AS}=f(T_j); I_D=4.4 \text{ A}; V_{DD}=50 \text{ V}$

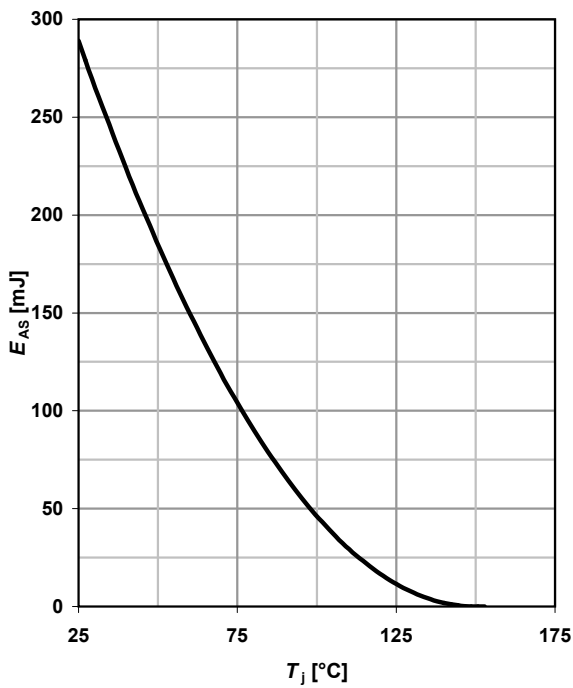

12 Drain-source breakdown voltage

$V_{BR(DSS)}=f(T_j); I_D=0.25 \text{ mA}$

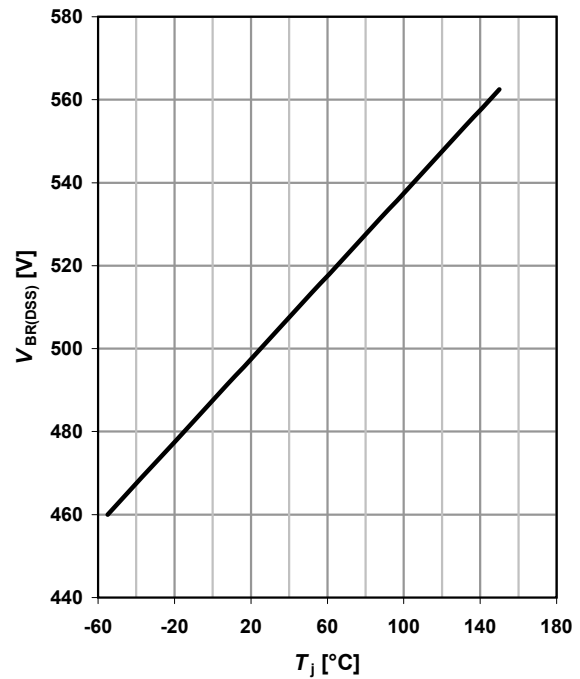

13 Typ. capacitances

$C=f(V_{DS}); V_{GS}=0\text{ V}; f=1\text{ MHz}$

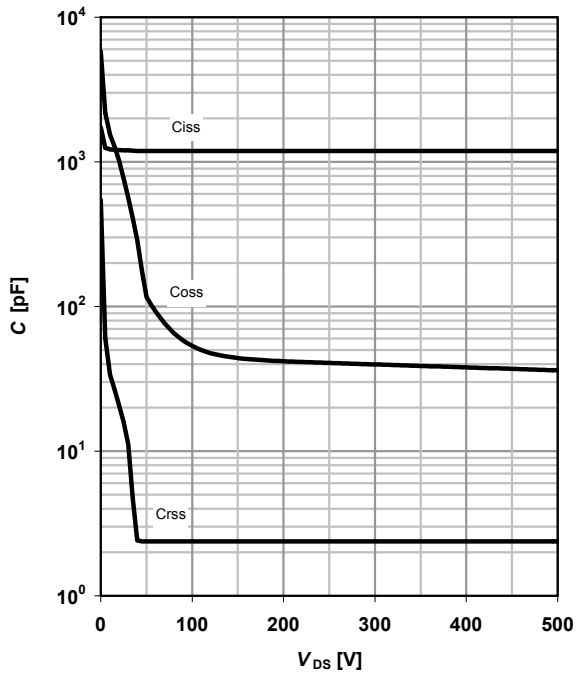

14 Typ. Coss stored energy

$E_{oss}=f(V_{DS})$

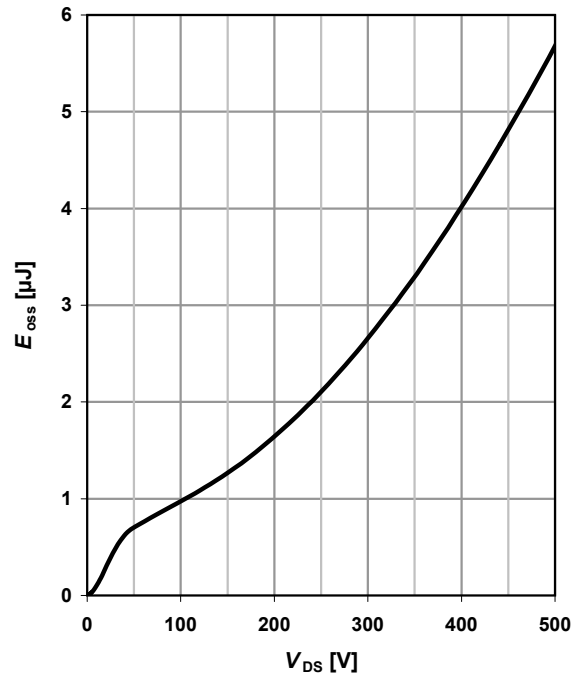

Definition of diode switching characteristics



PG-TO220-3-31;-3-111: Outline / Fully isolated package (2500VAC; 1minute)

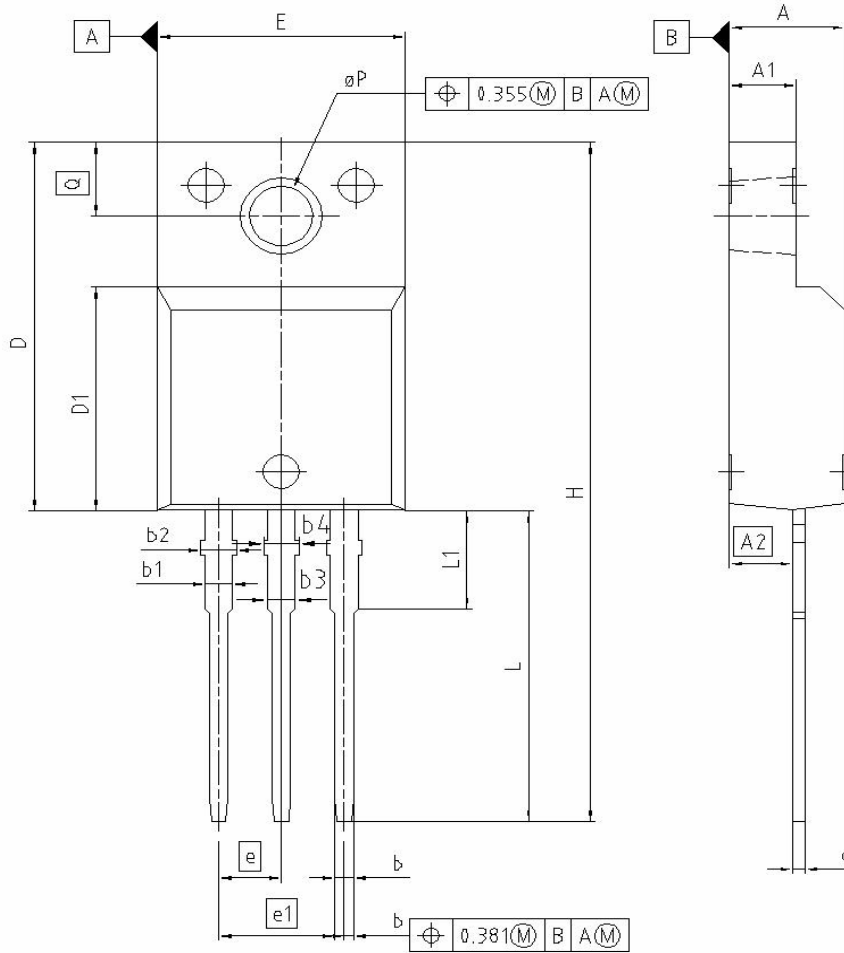

DIM	MILLIMETERS		INCHES	
	MIN	MAX	MIN	MAX
A	4.55	4.85	0.179	0.191
A1	2.55	2.85	0.100	0.112
A2	2.42	2.72	0.095	0.107
b	0.85	0.85	0.026	0.033
b1	0.95	1.33	0.037	0.052
b2	0.95	1.51	0.037	0.059
b3	0.65	1.33	0.026	0.052
b4	0.65	1.51	0.026	0.059
c	0.40	0.63	0.016	0.025
D	15.85	16.15	0.624	0.636
D1	9.53	9.83	0.375	0.387
E	10.35	10.65	0.407	0.419
e	2.54		0.100	
e1	5.08		0.200	
N	3		3	
H	29.45	29.75	1.159	1.171
L	13.45	13.75	0.530	0.541
L1	3.15	3.45	0.124	0.136
øP	2.95	3.20	0.116	0.126
Q	3.15	3.50	0.124	0.138

REFERENCE
..J..

SCALE
0
2.5
5mm

EUROPEAN PROJECTION

ISSUE DATE
08-01-2007

FILE
TO220_2

Published by
Infineon Technologies AG
81726 Munich, Germany
© 2007 Infineon Technologies AG
All Rights Reserved.

Legal Disclaimer

The information given in this document shall in no event be regarded as a guarantee of conditions or characteristics. With respect to any examples or hints given herein, any typical values stated herein and/or any information regarding the application of the device, Infineon Technologies hereby disclaims any and all warranties and liabilities of any kind, including without limitation, warranties of non-infringement of intellectual property rights of any third party.

Information

For further information on technology, delivery terms and conditions and prices, please contact the nearest Infineon Technologies Office
www.infineon.com

Warnings

Due to technical requirements, components may contain dangerous substances. For information on the types in question, please contact the nearest Infineon Technologies Office.
Infineon Technologies components may be used in life-support devices or systems only with the express written approval of Infineon Technologies, if a failure of such components can reasonably be expected to cause the failure of that life-support device or system or to affect the safety or effectiveness of that device or system. Life support devices or systems are intended to be implanted in the human body or to support and/or maintain and sustain and/or protect human life. If they fail, it is reasonable to assume that the health of the user or other persons may be endangered.